







Cable Glands for Non-armoured Cables

E-OCTANS

| Technical Details | |
|---|---|
| Material | Body, Cap Brass, Brass Nickel Plated, Stainless Steel 316L, Aluminium Seal CR (Chloroprene), Silicone O-ring CR (Chloroprene), Silicone |
| Ingress Protection Rating | IP 68 - 5 Bar, 30 min IP 66 |
| Operating Temperature | Seal Material CR (Chloroprene) -40°C to +80°C Silicone -60°C to +80°C |
| Equipment For | Gas & Dust potentially explosive atmospheres |
| Suitable for use in | Group II Gas Group IIC ZONE1/ZONE2 Group III Dust Group IIIC ZONE21/ZONE 22 |
| Equipment Marking | Ex II 2GD Ex db IIC Gb Ex eb IIC Gb Ex tb IIIC Db |
| Marking Example * | BMD EBU.. CE 0722  II 2GD Ex db IIC Gb Ex eb IIC Gb Ex tb IIIC Db Ta-40°C to +80°C IP66/68 IECEx CES 13.0006X CESI 13 ATEX 018X |
| Thread Type | • Metric (M) ISO Pitch 1,5 • NPT (N) ANSI ASME B1.20.1 • Other thread types also available upon request. |
| Cable Type | Non Armoured |
| Accessories | • Lock nuts • Gaskets (Washers) • Serrated Washers • Shrouds • Earth tags • Dome plugs |
| Remarks | • Accessories must be ordered separately. • O-ring available in Metric outer threads. |
| Approvals | Certificate Number Standards |
|  | IMQ 13 ATEX 018X EN 60079-0:2012+A11:2013 EN 60079-7:2015 EN 60079-31:2014 EN 60079-1:2014 |
|  | IECEx IMQ 13.0006X IEC 60079-0:2011 Edition:6 IEC 60079-7:2015 Edition:5 IEC 60079-31:2013 Edition:2 IEC 60079-1:2014 Edition:7 |
|  | 20150501-E474828 20161226-E199260 UL 2225, CAN/CSA-C22.2 No. 60079-0:11 CAN/CSA C22.2 No. 60079-7:12 CAN/CSA-C22.2 No. 60079-31:12 UL 514B UL50E |
|  | № TC RU C-TR.AA87.B.00941 ГОСТ 31610.0-2014 ГОСТ IEC 60079-1:2013 ГОСТ IEC 60079-31:2013 |
|  | DNV 12.0052 X ABNT NBR IEC 60079-0:2013 ABNT NBR IEC 60079-1:2009 ABNT NBR IEC 60079-7:2008 ABNT NBR IEC 60079-31:2011 |
|  | E-14044 IEC/EN60079-0 IEC/EN60079-7 IEC/EN60079-31 IEC/EN60079-1 IEC/EN 62444 |

-For more information see our webpage.

* The standard marking consists ATEX & IECEx only. Marking acc. to other standards on request.



| Order Coding | | | | | | | | | |
|----------------|--|-----------------------------|---|-------------|---------------------|------------|----------|-------------|----------|
| Part Number | Material | Seal | Gasket (Washer) | Seal Plug | Serrated Washer | Lock Nut | Shroud | Earth Tag | for Ex e |
| Mandatory | Mandatory | Mandatory | - Option | Option | Option | Option | Option | Option | Option |
| See table | B Brass BN Brass Nickel plated X Stainless Steel 316L A Aluminium | C Chloroprene S Silicone | - WC Chloroprene WS Silicone WF Fiber | P Dome Plug | WSR Serrated washer | L Lock nut | S Shroud | E Earth tag | TL9 |
| Example | EBU1N (*BUE) | BN | S | - WC | P | WSR | L | S | E TL9 |

* BUE: Part Number is valid for Customs Union certificate.

E-OCTANS

Cable Glands for Non-armoured Cables

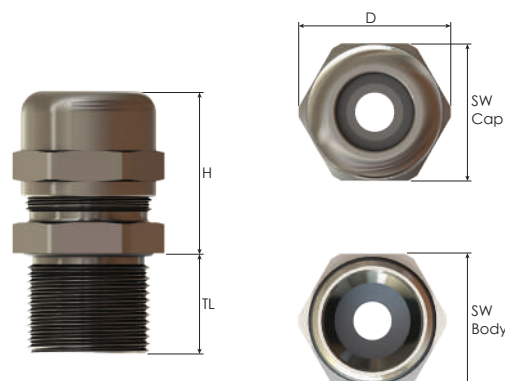







Thread Type **METRIC** acc. to ISO 965 - 3

| Outer Thread Size (Male) | Clamping Range | | Outer Thread Length | | Spanner Width | | Outer Ø | max. Height | Part Number |
|--------------------------|----------------|-----------|---------------------|-------------|---------------|-----------|---------|-------------|-------------|
| | Ø min - max mm | Seal Type | Ex-e min. | Ex-d/e min. | Cap | Body | | | |
| | | | TL mm | | SW Cap mm | SWBody mm | D mm | H mm | |
| M12x1,5 | 3,0 - 8,0 | Double | 9,0 | 16,0 | 20 | 20 | 22,0 | 29,0 | EBU0M |
| | 4,0 - 8,0 | Triple | 9,0 | 16,0 | 22 | 22 | 24,5 | 33,0 | EBU0SM |
| M16x1,5 | 3,0 - 9,0 | Double | 9,0 | 16,0 | 20 | 20 | 22,0 | 29,0 | EBU01SM |
| | 4,0 - 12,0 | Triple | 9,0 | 16,0 | 22 | 22 | 24,5 | 33,0 | EBU01M |
| M20x1,5 | 3,0 - 9,0 | Double | 9,0 | 16,0 | 20 | 22 | 24,5 | 29,0 | EBU1SM |
| | 4,0 - 12,0 | Triple | 9,0 | 16,0 | 22 | 22 | 24,5 | 29,0 | EBU1M |
| | 10,0 - 16,0 | Triple | 9,0 | 16,0 | 28 | 28 | 31,0 | 32,0 | EBU12M |
| M25x1,5 | 4,0 - 12,0 | Triple | 9,0 | 16,0 | 22 | 28 | 31,0 | 29,0 | EBU2SM |
| | 10,0 - 18,0 | Triple | 9,0 | 16,0 | 28 | 28 | 31,0 | 32,5 | EBU2M |
| | 14,0 - 20,0 | Triple | 9,0 | 16,0 | 35 | 35 | 39,0 | 36,0 | EBU23M |
| M32x1,5 | 10,0 - 18,0 | Triple | 9,0 | 16,0 | 28 | 35 | 39,0 | 32,5 | EBU3SM |
| | 14,0 - 24,0 | Triple | 9,0 | 16,0 | 35 | 35 | 39,0 | 35,0 | EBU3M |
| | 22,0 - 28,0 | Triple | 9,0 | 16,0 | 45 | 45 | 49,5 | 42,5 | EBU34M |
| M40x1,5 | 14,0 - 24,0 | Triple | 9,0 | 18,0 | 35 | 45 | 49,5 | 35,0 | EBU4SM |
| | 22,0 - 32,0 | Triple | 9,0 | 18,0 | 45 | 45 | 49,5 | 42,5 | EBU4M |
| | 26,0 - 34,0 | Triple | 9,0 | 18,0 | 50 | 50 | 56,0 | 45,5 | EBU45M |
| M50x1,5 | 22,0 - 32,0 | Triple | 9,0 | 18,0 | 45 | 55 | 61,0 | 42,5 | EBU5SM |
| | 26,0 - 35,0 | Triple | 9,0 | 18,0 | 50 | 55 | 61,0 | 45,5 | EBU5M |
| | 35,0 - 44,0 | Triple | 9,0 | 18,0 | 64 | 64 | 70,0 | 45,0 | EBU56M |
| M63x1,5 | 26,0 - 35,0 | Triple | 9,0 | 18,0 | 50 | 68 | 75,0 | 45,5 | EBU6SM |
| | 35,0 - 45,0 | Triple | 9,0 | 18,0 | 64 | 68 | 75,0 | 45,0 | EBU6M |
| | 46,0 - 56,0 | Triple | 9,0 | 18,0 | 80 | 75 | 89,0 | 54,0 | EBU67M |
| M75x1,5 | 35,0 - 45,0 | Triple | 9,0 | 20,0 | 64 | 80 | 89,0 | 45,0 | EBU7SM |
| | 46,0 - 62,0 | Triple | 9,0 | 20,0 | 80 | 80 | 89,0 | 54,0 | EBU7M |
| | 60,0 - 69,0 | Triple | 9,0 | 20,0 | 95 | 95 | 105,0 | 57,0 | EBU78M |
| M90x1,5 | 46,0 - 62,0 | Triple | 9,0 | 20,0 | 80 | 95 | 105,0 | 53,5 | EBU8SM |
| | 60,0 - 75,0 | Triple | 9,0 | 20,0 | 95 | 95 | 105,0 | 57,0 | EBU8M |
| | 75,0 - 82,0 | Triple | 9,0 | 20,0 | 105 | 105 | 117,0 | 56,0 | EBU810M |
| M100x1,5 | 60,0 - 75,0 | Triple | 9,0 | 20,0 | 95 | 105 | 117,0 | 57,0 | EBU10SM |
| | 75,0 - 85,0 | Triple | 9,0 | 20,0 | 105 | 105 | 117,0 | 56,0 | EBU10M |
| M110x1,5 | 85,0 - 95,0 | Triple | 9,0 | 20,0 | 115 | 115 | 128,0 | 58,0 | EBU11M |
| M115x2,0 | 75,0 - 85,0 | Triple | 9,0 | 24,0 | 105 | 130 | 144,0 | 56,0 | EBU115XSM |
| | 85,0 - 95,0 | Triple | 9,0 | 24,0 | 115 | 130 | 144,0 | 58,0 | EBU115SM |
| | 95,0 - 105,0 | Triple | 9,0 | 24,0 | 130 | 130 | 144,0 | 64,5 | EBU115M |
| M130x2,0 | 105,0 - 115,0 | Triple | 9,0 | 24,0 | 140 | 140 | 154,0 | 67,5 | EBU13M |

Cable Glands for Non-armoured Cables

E-OCTANS

| Technical Details | |
|---|---|
| Material | Body, Cap Brass, Brass Nickel Plated, Stainless Steel 316L, Aluminium Seal CR (Chloroprene), Silicone O-ring CR (Chloroprene), Silicone |
| Ingress Protection Rating | IP 68 - 5 Bar, 30 min IP 66 |
| Operating Temperature | Seal Material CR (Chloroprene) Silicone |
| Ex d/tb | -40°C to +80°C |
| Ex e/tb | -40°C to +80°C |
| Equipment For | Gas & Dust potentially explosive atmospheres |
| Suitable for use in | Group II Gas Group IIC ZONE1/ZONE2 Group III Dust Group IIIC ZONE21/ZONE 22 |
| Equipment Marking | Ex II 2GD Ex db IIC Gb Ex eb IIC Gb Ex tb IIIC Db |
| Marking Example * | BMD EBU.. CE 0722  II 2GD Ex db IIC Gb Ex eb IIC Gb Ex tb IIIC Db Ta-40°C to +80°C IP66/68 IECEx CES 13.0006X CESI 13 ATEX 018X |
| Thread Type | • Metric (M) ISO Pitch 1,5 • NPT (N) ANSI ASME B1.20.1 • Other thread types also available upon request. |
| Cable Type | Non Armoured |
| Accessories | • Lock nuts • Gaskets (Washers) • Serrated Washers • Shrouds • Earth tags • Dome plugs |
| Remarks | • Accessories must be ordered separately. • O-ring available in Metric outer threads. |
| Approvals | Certificate Number Standards |
|  | IMQ 13 ATEX 018X EN 60079-0:2012+A11:2013 EN 60079-7:2015 EN 60079-31:2014 EN 60079-1:2014 |
|  | IECEx IMQ 13.0006X IEC 60079-0:2011 Edition:6 IEC 60079-7:2015 Edition:5 IEC 60079-31:2013 Edition:2 IEC 60079-1:2014 Edition:7 |
|  | 20150501-E474828 UL 2225, CAN/CSA-C22.2 No. 60079-0:11 CAN/CSA C22.2 No. 60079-7:12 CAN/CSA-C22.2 No. 60079-31:12 |
|  | № TC RU C-TR.AA87.B.00941 UL 514B UL50E |
|  | DNV 12.0052 X ABNT NBR IEC 60079-0:2013 ABNT NBR IEC 60079-1:2009 ABNT NBR IEC 60079-7:2008 ABNT NBR IEC 60079-31:2011 |
|  | E-14044 IEC/EN60079-0 IEC/EN60079-7 IEC/EN60079-31 IEC/EN60079-1 IEC/EN 62444 |

-For more information see our webpage.

* The standard marking consists ATEX & IECEx only. Marking acc. to other standards on request.



| Order Coding | | | | | | | | |
|----------------|--|-----------------------------|---|-------------|---------------------|------------|----------|-------------|
| Part Number | Material | Seal | Gasket (Washer) | Seal Plug | Serrated Washer | Lock Nut | Shroud | Earth Tag |
| Mandatory | Mandatory | Mandatory | - Option | Option | Option | Option | Option | Option |
| See table | B Brass BN Brass Nickel plated X Stainless Steel 316L A Aluminium | C Chloroprene S Silicone | - WC Chloroprene WS Silicone WF Fiber | P Dome Plug | WSR Serrated washer | L Lock nut | S Shroud | E Earth tag |
| Example | EBU1N (*BUE) BN | S | - WC | P | WSR | L | S | E |

* BUE: Part Number is valid for Customs Union certificate.

E-OCTANS

Cable Glands for Non-armoured Cables

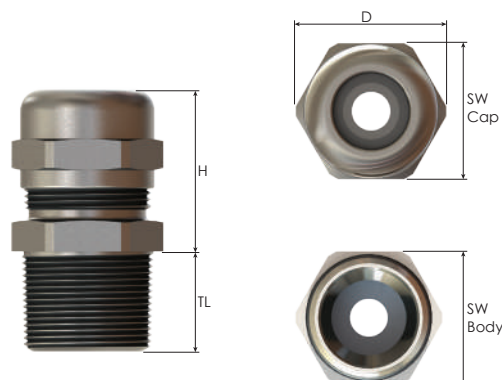

Thread Type **NPT** acc. to ANSI ASME B1.20.1

| Outer Thread Size (Male) | Clamping Range | | Outer Thread Length TL mm | Spanner Width | | Outer Ø D mm | max. Height H mm | Part Number |
|--------------------------|-------------------|-----------|---------------------------------|---------------|---------------|--------------------|------------------------|-------------|
| | Ø min - max mm | Seal Type | | SW Cap mm | SW Body mm | | | |
| NPT 1/4" | 3,0 - 8,0 | Double | 16 | 20 | 20 | 22,0 | 29,0 | EBU0N |
| | 4,0 - 8,0 | Triple | 16 | 22 | 22 | 24,5 | 33,0 | EBU0SN |
| NPT 3/8" | 3,0 - 9,0 | Double | 16 | 20 | 20 | 22,0 | 29,0 | EBU01SN |
| | 4,0 - 12,0 | Triple | 16 | 22 | 22 | 24,5 | 33,0 | EBU01N |
| NPT 1/2" | 3,0 - 9,0 | Double | 16 | 20 | 22 | 24,5 | 29,0 | EBU1SN |
| | 4,0 - 12,0 | Triple | 16 | 22 | 22 | 24,5 | 29,0 | EBU1N |
| | 10,0 - 16,0 | Triple | 16 | 28 | 28 | 31,0 | 32,0 | EBU12N |
| NPT 3/4" | 4,0 - 12,0 | Triple | 16 | 22 | 28 | 31,0 | 29,0 | EBU2SN |
| | 10,0 - 18,0 | Triple | 16 | 28 | 28 | 31,0 | 32,0 | EBU2N |
| | 14,0 - 20,0 | Triple | 16 | 35 | 35 | 39,0 | 35,0 | EBU23N |
| NPT 1" | 10,0 - 18,0 | Triple | 20 | 28 | 35 | 39,0 | 32,5 | EBU3SN |
| | 14,0 - 24,0 | Triple | 20 | 35 | 35 | 39,0 | 35,0 | EBU3N |
| | 22,0 - 26,0 | Triple | 20 | 45 | 45 | 49,5 | 42,0 | EBU34N |
| NPT 1 1/4" | 14,0 - 24,0 | Triple | 20 | 35 | 45 | 49,5 | 35,0 | EBU4SN |
| | 22,0 - 32,0 | Triple | 20 | 45 | 45 | 49,5 | 42,5 | EBU4N |
| | 26,0 - 34,0 | Triple | 20 | 50 | 50 | 56,0 | 45,5 | EBU45N |
| NPT 1 1/2" | 22,0 - 32,0 | Triple | 20 | 45 | 55 | 61,0 | 42,5 | EBU5SN |
| | 26,0 - 35,0 | Triple | 20 | 50 | 55 | 61,0 | 45,5 | EBU5N |
| | 35,0 - 41,0 | Triple | 20 | 64 | 64 | 70,0 | 44,0 | EBU56N |
| NPT 2" | 26,0 - 35,0 | Triple | 20 | 50 | 68 | 75,0 | 45,5 | EBU6SN |
| | 35,0 - 45,0 | Triple | 20 | 64 | 68 | 75,0 | 45,0 | EBU6N |
| | 46,0 - 52,0 | Triple | 20 | 80 | 75 | 89,0 | 54,0 | EBU67N |
| NPT 2 1/2" | 35,0 - 45,0 | Triple | 21 | 64 | 80 | 89,0 | 45,0 | EBU7SN |
| | 46,0 - 62,0 | Triple | 21 | 80 | 80 | 89,0 | 53,5 | EBU7N |
| | 60,0 - 64,0 | Triple | 21 | 95 | 95 | 105,0 | 57,0 | EBU78N |
| NPT 3" | 46,0 - 62,0 | Triple | 21 | 80 | 95 | 105,0 | 53,5 | EBU8SN |
| | 60,0 - 75,0 | Triple | 21 | 95 | 95 | 105,0 | 57,0 | EBU8N |
| | 75,0 - 79,5 | Triple | 21 | 105 | 105 | 117,0 | 56,0 | EBU810N |
| NPT 4" | 60,0 - 75,0 | Triple | 21 | 95 | 115 | 128,0 | 57,0 | EBU108N |
| | 75,0 - 85,0 | Triple | 21 | 105 | 115 | 128,0 | 56,0 | EBU10N |
| | 85,0 - 95,0 | Triple | 21 | 115 | 115 | 128,0 | 58,0 | EBU11N |
| | 95,0 - 101,0 | Triple | 21 | 130 | 130 | 144,0 | 64,5 | EBU115N |
| NPT 5" | 95,0 - 105,0 | Triple | 27 | 130 | 145 | 162,0 | 64,5 | EBU13N |
| | 105,0 - 115,0 | Triple | 27 | 140 | 145 | 162,0 | 67,5 | EBU130N |